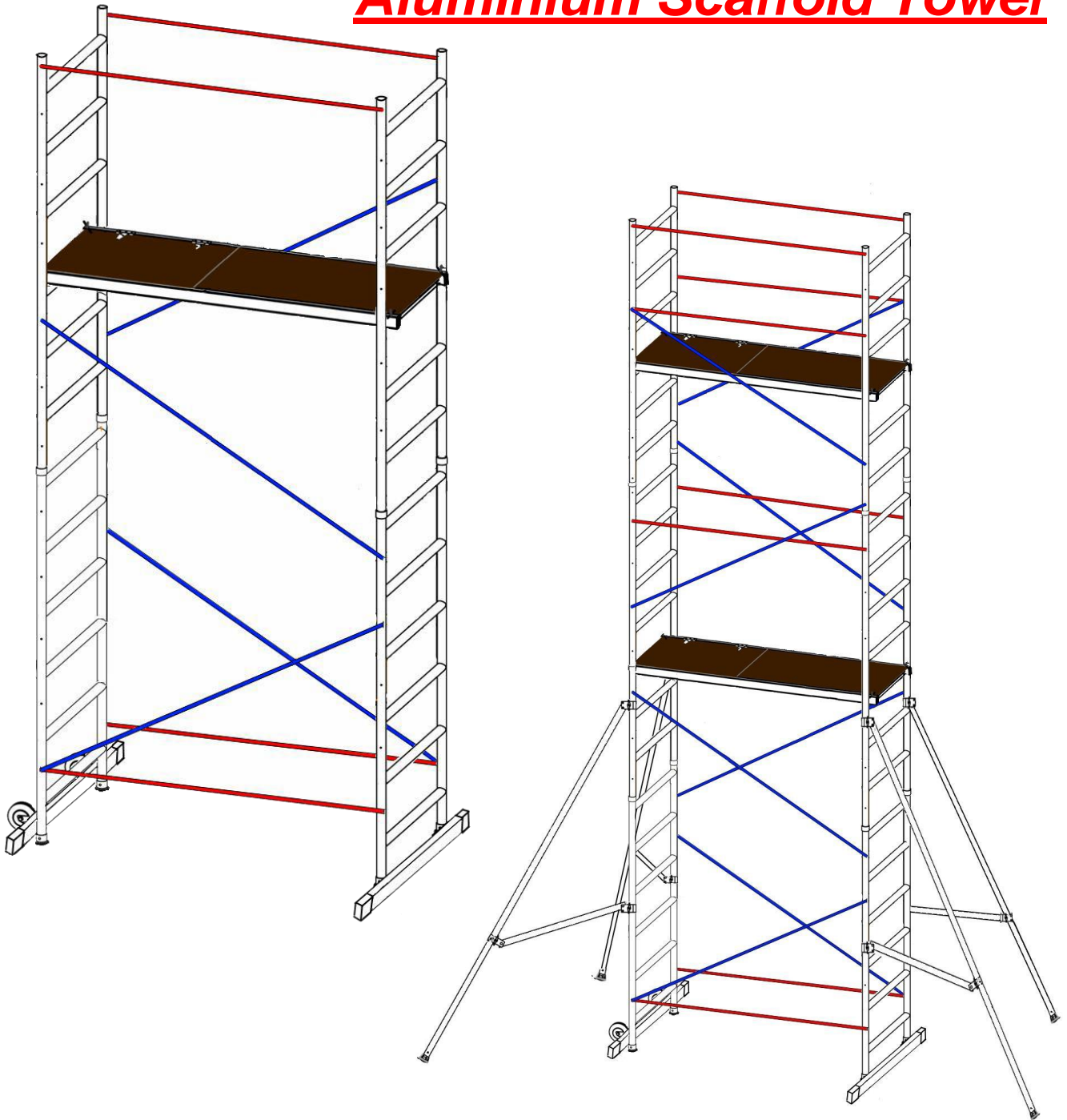


# HOME MASTER

5m & 7m Home Master

Aluminium Scaffold Tower



**ACCESS SOLUTIONS**

**BPS Access Solutions Ltd**

Tel: +44 (0) 333 006 9776 Fax: +44 (0) 1959 572932

LADDERS • LOFT LADDERS • SCAFFOLD TOWERS

[sales@bpsaccesssolutions.co.uk](mailto:sales@bpsaccesssolutions.co.uk) [www.laddersandscaffoldtowers.co.uk](http://www.laddersandscaffoldtowers.co.uk)

## INTRODUCTION

**PLEASE NOTE:** Working at Height can be dangerous Please make sure you have read and understood the Safety Notes before use.

**BE AWARE:** For anything other than light DIY or internal work we strongly recommend the use of at least 2 x outriggers on the 4 and 5m towers.

Please note that diagrams are for illustrative purposes only.

Home Master mobile aluminum towers are light-weight scaffold towers and can be used both indoors and outdoors where a stable and secure platform is required. Ideal for maintenance, installation work or short-term access. These highly versatile towers provide a strong working platform over a variety of heights.

This User Guide provides you with step by step instructions to ensure your system is erected easily and safely.

If you need further information, design advice, additional guides or any other help with this product, please contact : **BPS Access Solutions Ltd.** on +44 (0) 333 006 9776 or email : [customerservices@bpsaccesssolutions.co.uk](mailto:customerservices@bpsaccesssolutions.co.uk)

**THIS TOWER IS FOR HOME USE ONLY.**

## Safety First

### PREPARATION AND INSPECTION

Inspect the equipment before use to ensure that it is not damaged and that it functions properly. Damaged or incorrect components must not be used.

#### **A. SAFETY NOTES**




1. IF IN DOUBT **DO NOT ERECT**
2. Check that all components are undamaged and that they are functioning correctly – (refer to Checklist & Quantity Schedule on page 5). Damaged or incorrect components must not be used.
3. Before erecting the tower, check that the location for the mobile access tower does not present any hazards during erecting, dismantling, moving and safe working with respect to :-  
  
Ground conditions - Check if the ground on which the mobile access tower is to be erected and moved is capable of supporting the tower.  
Level and slope  
Obstructions (ground and overhead)  
Wind conditions (current and potential) – see Wind Speed Safety Rules (Page 3)
4. The mobile scaffold tower **MUST** only be erected on a horizontal level surface (or over steps etc in the designated way).
5. The safe working load is **150kg** uniformly distributed.
6. Tower **MUST ALWAYS** be climbed from the inside using the frame provided during assembly, dismantling and use.
7. **DO NOT** Climb up the outside of the tower.
8. **YOU MUST ONLY** climb onto the frames from the ground.
9. **DO NOT** use any other object than the tower itself to hold onto when climbing.
10. **DO NOT** use a Step Ladder/Ladder or any other equipment to gain access to the tower or platform.
11. It is recommended that towers should be tied to a solid structure when left unattended.
12. **DO NOT** use boxes, ladders or other objects on the platform to gain additional height.
13. **DO NOT** use braces as a rung or step


14. **NEVER** bridge between a tower and a building.
15. **DO NOT** brace yourself against the side guards when working.
16. **NEVER** jump onto platforms.
17. When possible, tie in the tower to a rigid structure when working outdoors or in exposed conditions.
18. Beware of the funneling effect of open ended and unclad buildings.
19. Raising and lowering components, tools, or materials by rope should be conducted within the tower base. Ensure that the safe working load is not exceeded. **NEVER** raise or lower components over the side of the tower.
20. The assembled tower is a working platform and should not be used as a means of access to other structures.
21. **NEVER** over-reach or lean over the side of the towers, **ALWAYS** ensure you remain within the confines of the platform.
22. **NEVER** lean anything against the tower.
23. The maximum wind conditions for moving the tower is between Beaufort Scale 0-3 as described in the Wind Speed Safety Rules on page 3.
24. **BE AWARE** of horizontal forces (lateral force) when using power tools, jet washers or other tools which could generate instability.
25. Mobile towers are not designed to be suspended.
26. Do not use any lifting equipment on the mobile scaffold tower.
27. Always beware of live electrical apparatus and cables when erecting, using or moving tower.
28. Before each use or re-use of the mobile tower check the tower is vertical with a spirit level, the structure is still assembled correctly and is complete. Ensure no environmental change has affected the tower (snow, wind, ice etc). If so, correct as necessary before use.

## Safety First

### B. WIND SPEED SAFETY RULES

1. Beware of high winds, gusty or medium breeze conditions. We recommend that in wind speeds over 20.0 km/h, cease working on the tower and do not attempt to move it. If the wind becomes a strong breeze, expected to reach 31.0 km/h, tie the tower to a rigid structure. If the wind is likely to reach gale force, over 52.0 km/h, the tower should be dismantled.
2. Wind force can be magnified by the tunneling effect of open ended and unclad buildings.

Beaufort Scale	WIND DESCRIPTION	SPEED In km/h.	SPEED In m/s.	GENERAL EFFECT		ACTION
0-3	Light Breeze	<2-19`	<0.6-5.3`	Raises dust.		No action required.
4	Moderate Breeze	20-30	5.6-8.3	Loose paper, twigs snap off.		Cease working on tower and do not attempt to move it.
5-6	Strong Breeze	31-51	8.6-14.2	Large branches in motion move. Telephone wires whistle.		Tie the tower to a rigid structure.

>6-8	Gale Force	52-75	14.4-20.8	Walking progress impeded.		Dismantle tower if such conditions are expected.
------	------------	-------	-----------	---------------------------	---	--

### C. LIFTING OF EQUIPMENT

1. Tower components should be lifted using a reliable lifting material (e.g. strong rope), employing a reliable knot (e.g. clove hitch) to ensure safe fastening and always lift within the footprint of the tower.
2. Assembled mobile towers should not be lifted with a crane or other lifting device.

### D. OUTRIGGERS

1. Outriggers shall always be fitted when specified.

### E. MOVEMENT

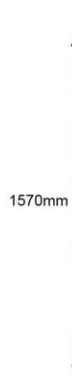
1. The tower should only be moved by manual effort, and only from the base.
2. When moving the tower, always beware of any live electrical apparatus, overhead cables or moving parts of machinery.
3. Ensure that all people and tools are removed prior to movement.
4. Caution should be exercised when wheeling a tower over rough, uneven or sloping ground. If outriggers are fitted, they should only be lifted sufficiently above the ground to clear ground obstructions.
5. Before use, check the tower is still correct and complete.
6. After every movement of the tower use a spirit level to check that it is level.
7. Do not move the tower in wind speeds over 20 km/hour.
8. Dismantle all towers above 5m working height before moving.

## Safety First

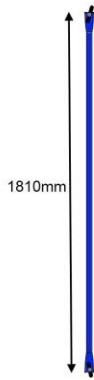
### F. MAINTENANCE – STORAGE – TRANSPORT

1. All components and their parts should be regularly inspected to identify damage, particularly to joints. Lost or broken parts should be replaced.
2. Wing nuts and bolts, frame interlock clips and platform J bolts should be regularly checked to ensure they lock tightly.
3. Components should be stored with due care to prevent damage.
4. Ensure components are not damaged when being transported.
5. Store platform(s) in a cool dry environment.

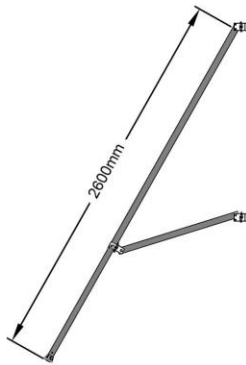
# Home Master Scaffold Tower Components



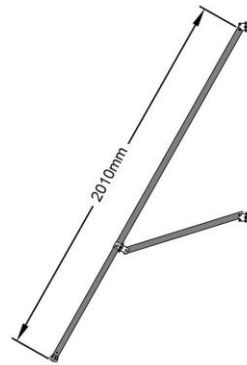
**PART A**  
Horizontal  
Red Brace



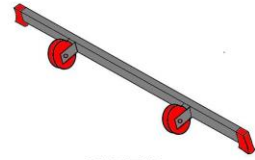
**PART B**  
Diagonal  
Blue Brace



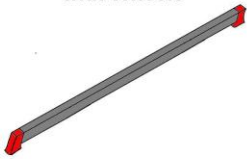
**PART C**  
Telescopic  
Outriggers



**OPTIONAL EXTRA:**  
Fixed Outriggers for  
4m & 5m DIY Tower



**PART D**  
Stabiliser Bars  
with Wheels



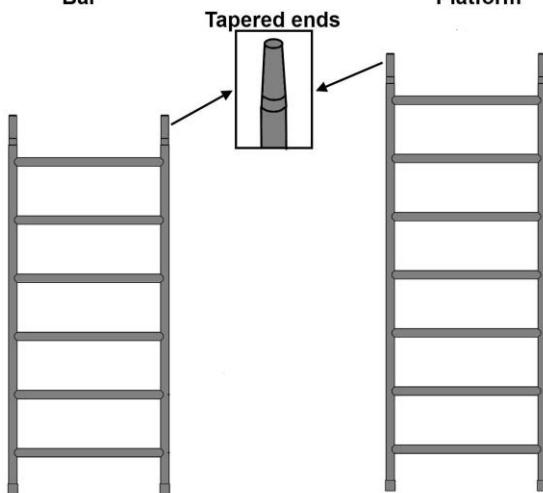
**PART E**  
Stabiliser  
Bar



**PART F**  
Trapdoor  
Platform



**PART G**  
6 Rung Non  
Tapered Frame



**PART H**  
6 Rung  
Tapered Frame



**PART I**  
7 Rung  
Tapered Frame



**PART J**  
3 Rung Non  
Tapered Frame





A - Red horizontal brace



B - Blue Diagonal Brace



C - Telescopic Outriggers



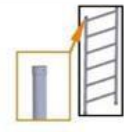
D - Stabiliser Bar With Wheels



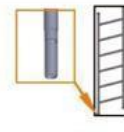
E - Stabiliser Bar



F - Trapdoor Platform



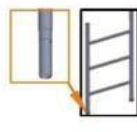
G - 6 Rung Non Tapered Frame



H - 6 Rung Tapered Frame



I - 7 Rung Tapered Frame



J - 3 Rung Tapered Frame

5m DIY ALUMINIUM SCAFFOLD TOWER	1 PACK	x4	x4	-	x1	x1	x1	x2	x2	-	-
2m EXTENSION PACK - EXTEND 5m TO 7M	1 PACK	x4	x4	x4	-	-	x1	-	-	x2	-
7m DIY ALUMINIUM SCAFFOLD TOWER	2 PACK	x8	x8	x4	x1	x1	x2	x2	x2	x2	-

Tower Size	Length	Width	Height	Maximum Platform Height	Maximum Working / Reach Height	Platform Size	Weight	Stored Size
5m (16'5")	1.76m (5'9")	0.68m (2'3") 1.22m (4') Including Stabiliser bars	4m (13'2")	3m (9'10")	5m (16'5")	1.45m x 0.5m (4'9"x1'8")	24.5kg	2.10m x 0.66m x 0.20m (6'11" x 2'2" x 8")
7m (23')	1.76m (5'9")	0.68m (2'3") 1.22m (4') Including Stabiliser bars	6m (19'8")	5m (16'5")	7m (23')	1.45m x 0.5m (4'9"x1'8")	52.7kg	2.20m x 0.66m x 0.40m (7'3" x 2'2" x 1'4")

### PLATFORMS LOADING

The maximum safe working load that may be placed on a platform is 150 kg, evenly distributed over the platform(s).

### OUTRIGGERS

To improve rigidity, outriggers can be purchased and used on lower heights than shown in the table above.

### When building a Home Master Scaffold Tower

- ◆ All platforms feature guardrails on both faces of the platform(s).
- ◆ Never stand on an unguarded platform positioned above the third rung of this tower.

### TO DISMANTLE A Home Master Scaffold Tower

- ◆ Undo braces from a seated position inside the trapdoor platform.
- ◆ Remove upper platforms from protected levels below.
- ◆ Pass removed components out of the tower to a colleague within the tower footprint.

### **Safety Checklist**

#### CHECKLIST

1. Inspect components prior to erection
2. Inspect tower once erected prior to use
3. Tower upright and level
4. Diagonal & Horizontal braces fitted securely
5. Outriggers fitted as specified

# Assembly Procedure

## ASSEMBLY FOR 5m Home Master SCAFFOLD TOWERS

1. Tighten wing nuts and bolts through stabiliser bar and either side of the 6 rung non tapered frame and do the same with the bolt running through the casing for the 2 wheels first at the other end of the tower (See figure 1). Attach (if not already done so) 1 blue and 1 red brace together (see figure 2) and using wing nuts and bolts fasten the red brace running horizontally between the 1st and 2nd rung with the blue brace attached diagonally to the 4th and 5th rung (Figure 3). Do the same on the other side of the tower but run the blue brace in the opposite direction.

Figure 1.

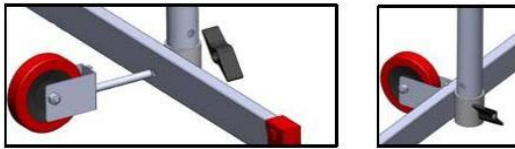


Figure 2.

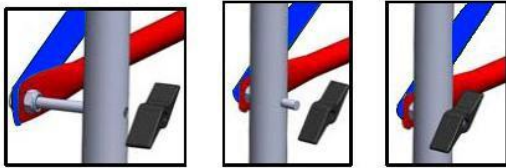
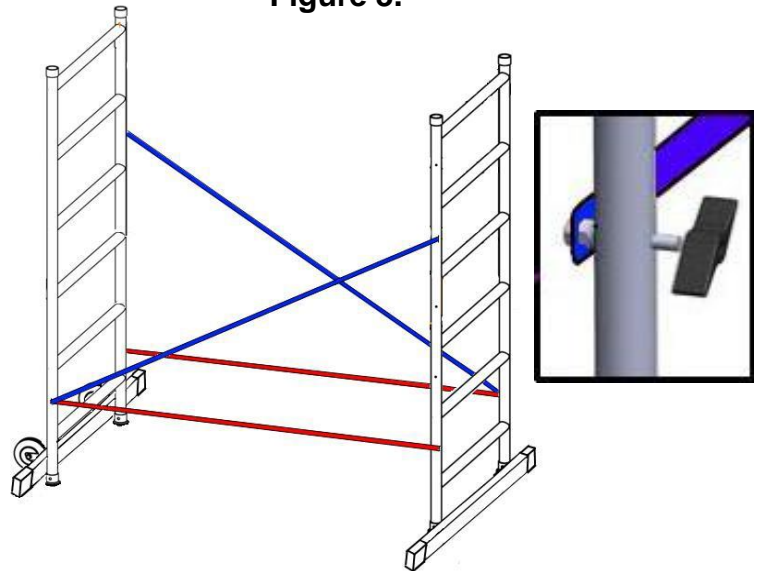


Figure 3.



2. Fasten one end of a blue diagonal brace using the wing nut and bolt provided between the 4th & 5th rung from the top of one of the 6 rung tapered frames. Fasten one end of another blue diagonal brace using the wing nut and bolt provided between the 2nd & 3rd rung from the top of the other 6 rung tapered frame (Figure 4a) on the opposite side. Also fasten one end of a red horizontal brace at the top of the 6 rung tapered frame and do the same but on the opposite side of the other 6 rung tapered frame (Figure 4b). Slot the 6 rung tapered frames down into the 6 rung non tapered frames and pass the spring pins through them (Figure 5a). Secure the other end of the blue diagonal braces using the wing nuts and bolts provided through the hole between the 5th & 6th rungs and 7th & 8th rungs from the bottom of the tower (Figure 5b). Ensure the blue diagonal bars are at the opposite angle to the ones fitted below it on the same side.

Figure 4a.

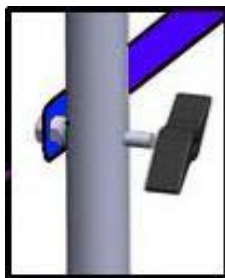


Figure 4b.

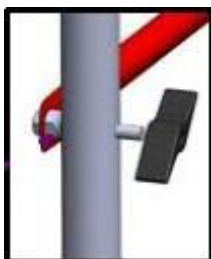


Figure 5b.

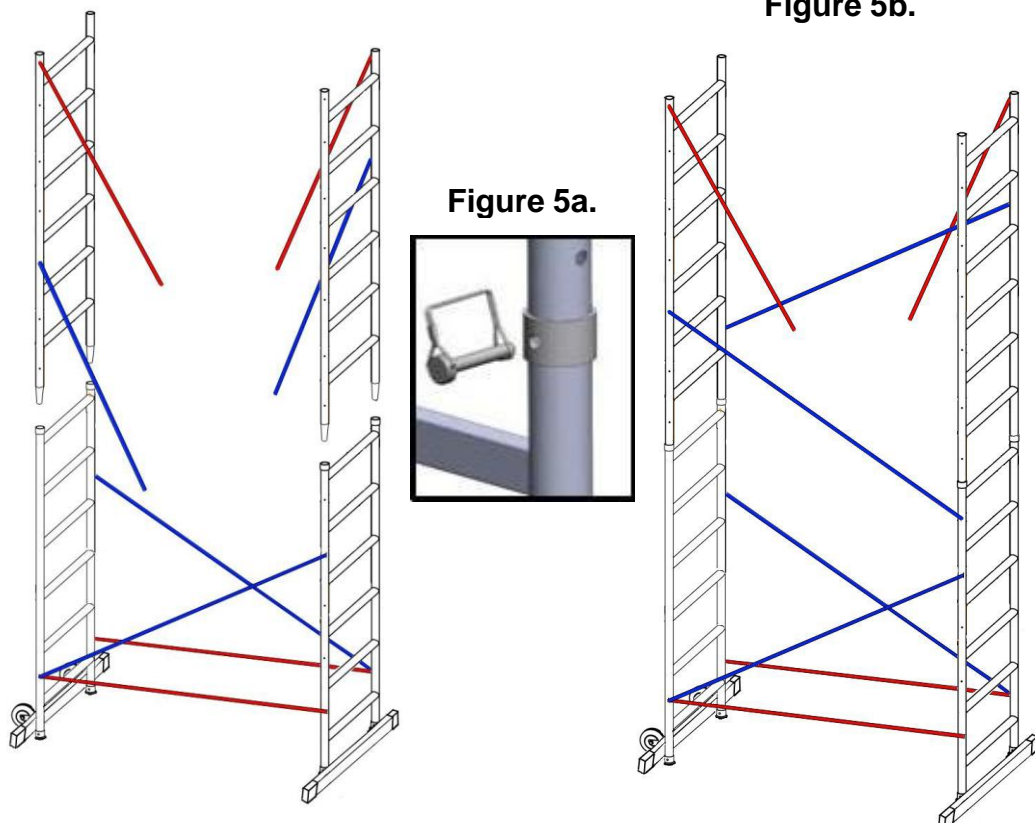
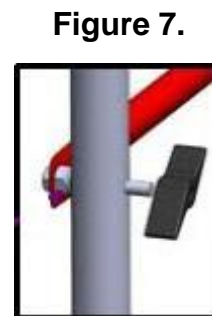
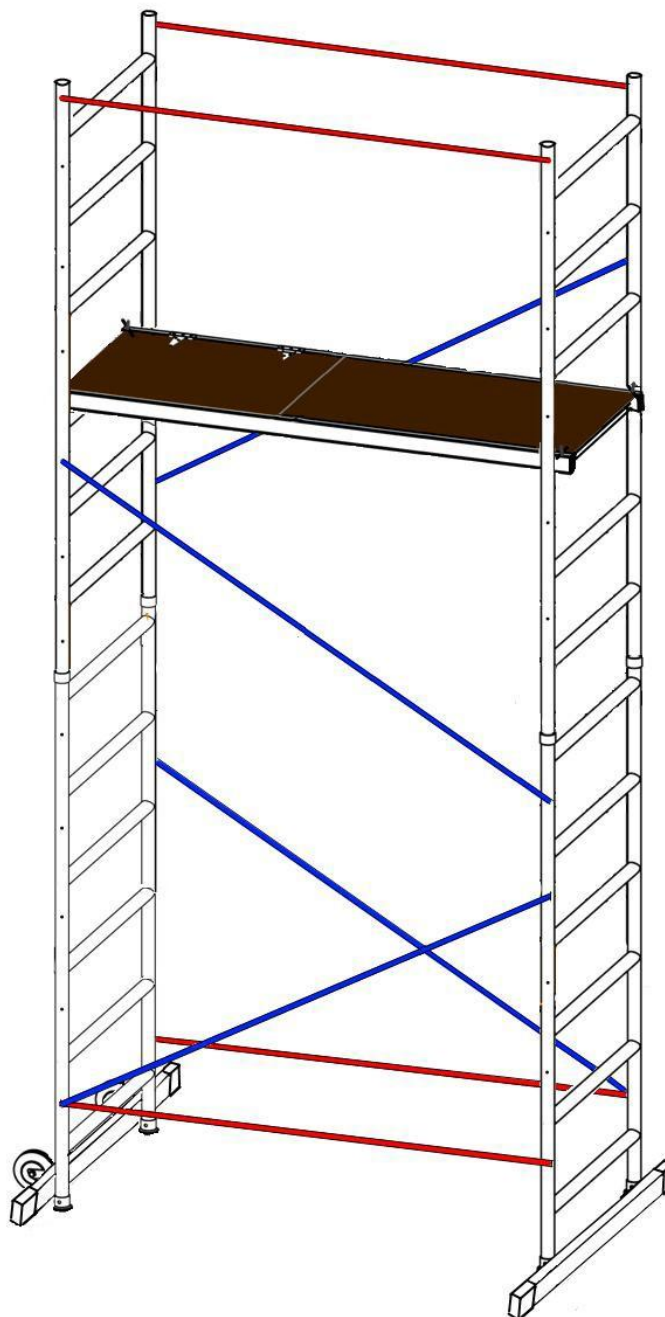
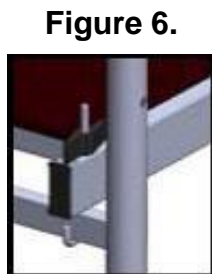


Figure 5a.





3. Place the trapdoor platform on the 9th rung and hook and secure J bolts to all 4 corners (Figure 6). Fasten remaining hanging red braces horizontally using the wing nuts and bolts provided to make hand rails (Figure 7). **WARNING! Remember to sit inside the trapdoor whilst installing these red braces for your own safety.**



### **Dismantle Procedure**

To take down the tower reverse the erection sequence. When removing red guardrail braces at the top of the tower remember to sit inside the trapdoor platform. You can refit the platform further down the tower to aid in dismantling it.

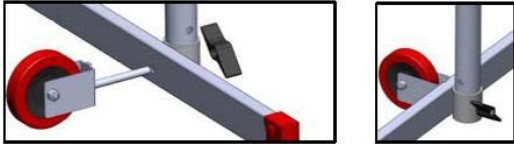
# Assembly Procedure

## ASSEMBLY FOR 7m Home Master SCAFFOLD TOWERS

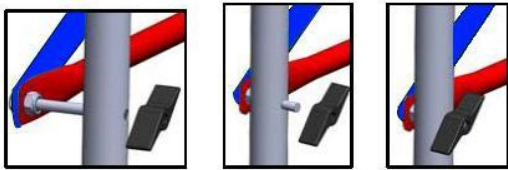
**PLEASE NOTE:** For this size tower you will receive 2 separate packs. One will be labeled a 5m DIY Tower and the other will be a 2m extension kit.

1. Tighten wing nuts and bolts through stabiliser bar and either side of the 6 rung non tapered frame and do the same with the bolt running through the casing for the 2 wheels first at the other end of the tower (See figure 1). Attach (if not already done so) 1 blue and 1 red brace together (see figure 2) and using wing nuts and bolts fasten the red brace running horizontally between the 1st and 2nd rung with the blue brace attached diagonally to the 4th and 5th rung (Figure 3). Do the same on the other side of the tower but run the blue brace in the opposite direction.

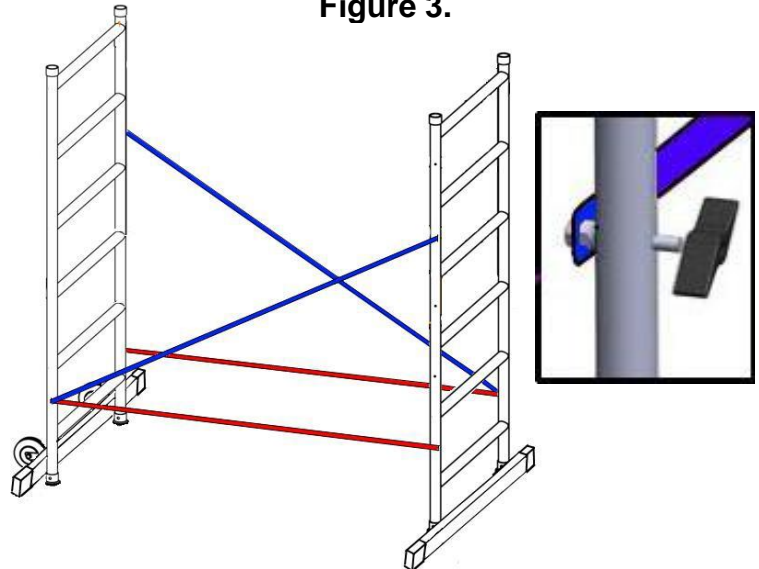
**Figure 1**



**Figure 2.**



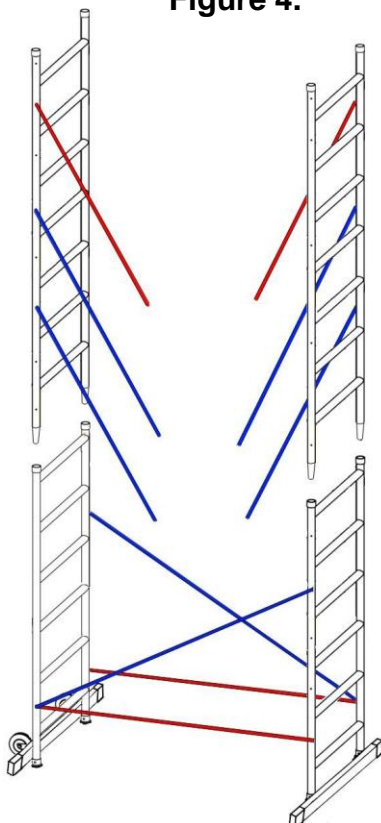
**Figure 3.**



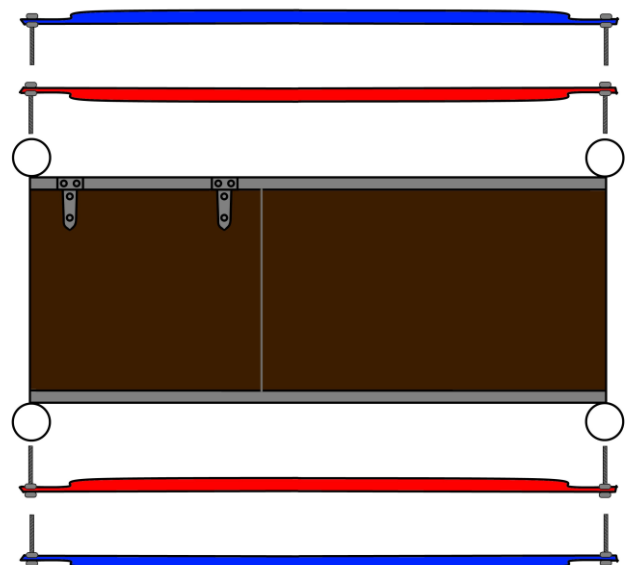
2. Fasten one end of 2 blue diagonal braces using the wing nut and bolt provided between the 3<sup>rd</sup> & 4<sup>th</sup> rung and between the 5<sup>th</sup> & 6<sup>th</sup> rung from the top of the 7 rung tapered frame (Figure 4) which is found in the 2m extension kit. Also fasten one end of a red horizontal brace between the 1st & 2nd rung from the top of the same 7 rung tapered frame. Fasten one end of 2 blue diagonal braces using the wing nut and bolt provided between the 3<sup>rd</sup> & 4<sup>th</sup> rung and between the 5<sup>th</sup> & 6<sup>th</sup> rung from the top of the other 7 rung tapered frame to the opposite side. Also fasten one end of a red horizontal brace between the 1st & 2nd rung from the top of the same 7 rung tapered frame to the opposite side.

**PLEASE NOTE:** Be sure to fasten the red horizontal braces in this stage with the tongue pointing inwards towards the tower and also ensure the tongue is pointing outwards from the tower for the blue braces installed between the 3<sup>rd</sup> & 4<sup>th</sup> rung from the top of the 7 rung tapered frames (Figure 5.). This will help the braces pass by one another in a later stage.

**Figure 4.**



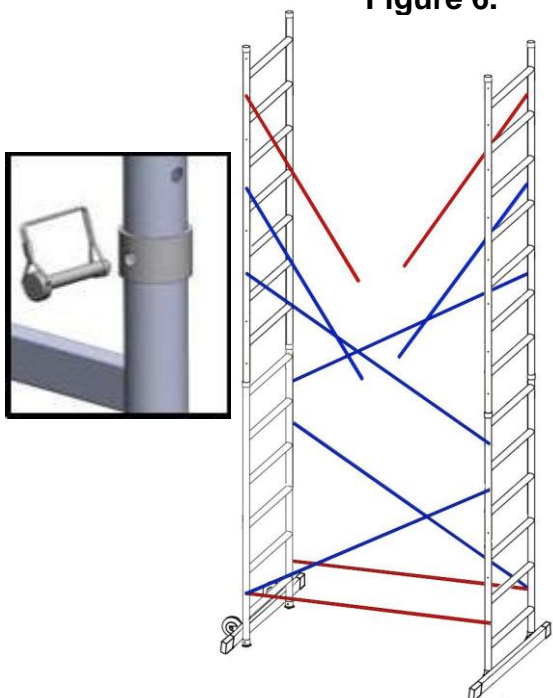
**Figure 5.**



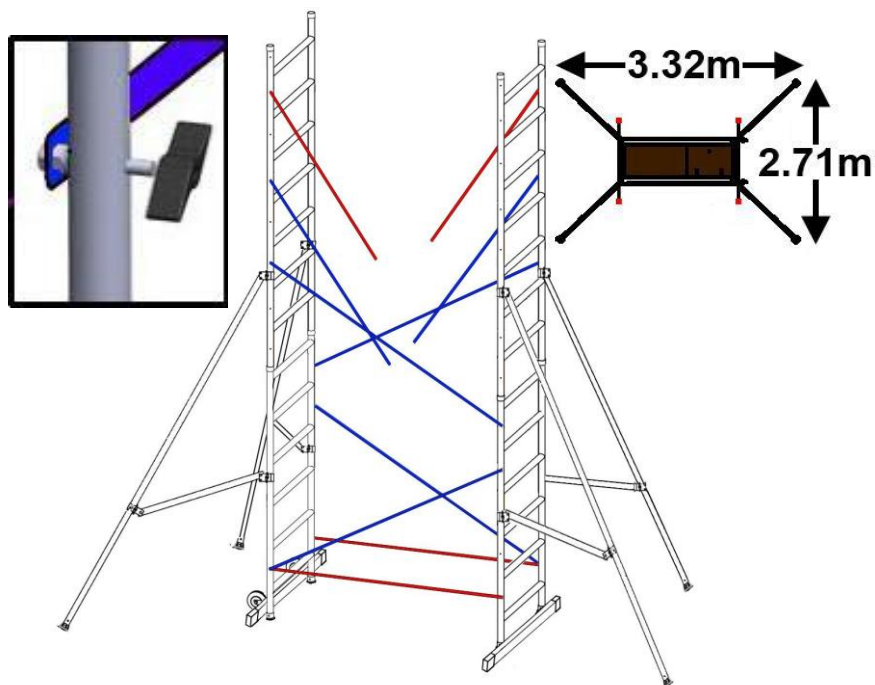
- Slot the 7 rung tapered frames down into the 6 rung non tapered frames and pass the spring pins through them (Figure 6). Secure the other end of the 2 lowest hanging blue diagonal braces (one on each side of the tower) using the wing nuts and bolts provided between the 5th & 6th rungs from the bottom of the tower. Ensure the blue diagonal bars are at the opposite angle to the ones fitted below it on the same side. Extend the outriggers to maximum length and secure with spring pins. Fasten securely the 4 outriggers to maximum length and secure with spring pins. Diagonally from the tower as in the birds eye view (Figure 7).

**PLEASE NOTE:** It is good practice to ensure that the shorter outrigger arm connecting lower down the tower is as close to parallel with the ground as possible.

**Figure 6.**



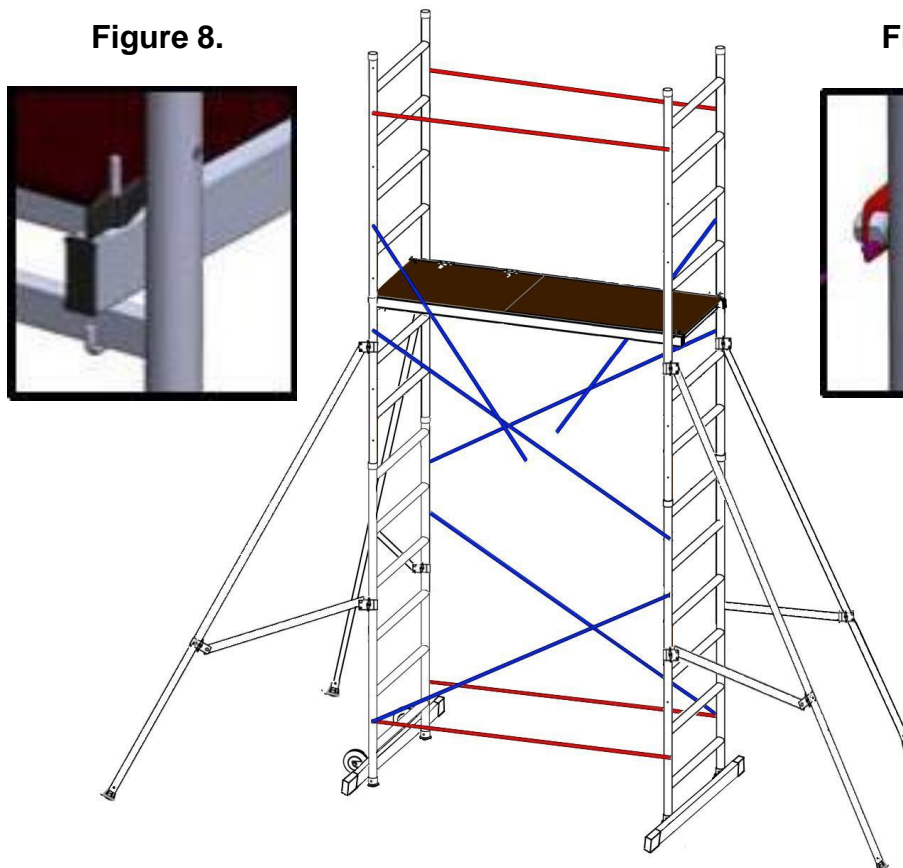
**Figure 7.**



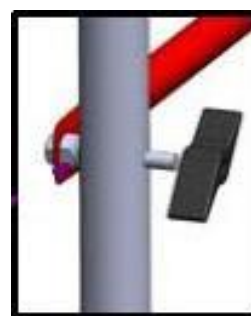
- Place the trapdoor platform on the 9th rung and hook and secure J bolts to all 4 corners (Figure 8). Fasten the other ends of the red horizontal braces using the wing nuts and bolts provided to either side of the tower (Figure 9).

**WARNING! Remember to sit inside the trapdoor whilst installing these red braces for safety.**

**Figure 8.**

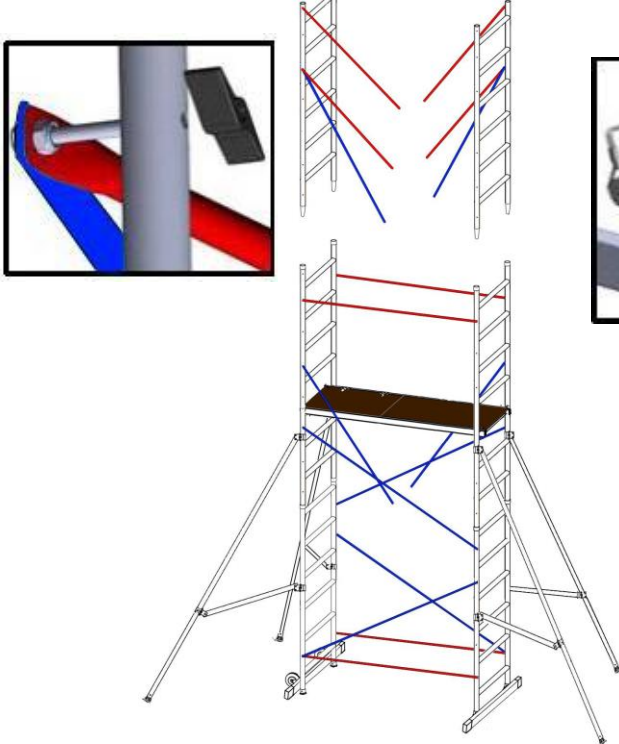


**Figure 9.**



- Attach (if not already done so) 1 blue and 1 red brace together and using wing nuts and bolts fasten between the 2<sup>nd</sup> & 3<sup>rd</sup> rung from the top of the 6 rung tapered frame. Do the same but in the opposite direction on the opposite side of the other 6 rung tapered frame (Figure 10). Also fasten one end of a red horizontal brace at the top of the 6 rung tapered frame and do the same but on the opposite side of the other 6 rung tapered frame. Slot the 6 rung tapered frames down into the 7 rung tapered frames and pass the spring pins through them (Figure 11). Secure the other ends of the 4x blue diagonal braces using the wing nuts and bolts provided between the 13<sup>th</sup> & 14<sup>th</sup> rungs and 14<sup>th</sup> & 15<sup>th</sup> rungs from the bottom of the tower (Figure 12). Ensure the blue diagonal bars are at the opposite angle to the ones fitted below it on the same side.

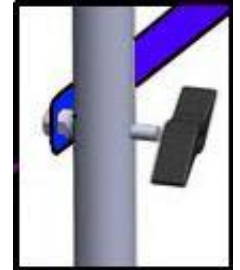
**Figure 10.**



**Figure 11.**



**Figure 12.**

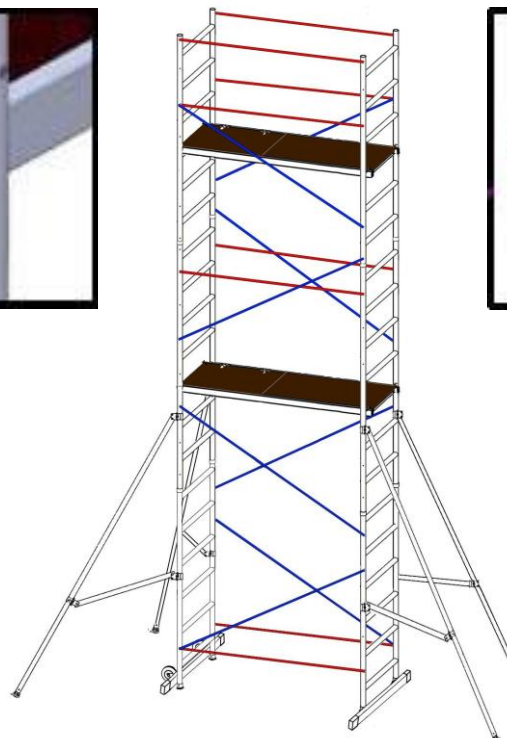
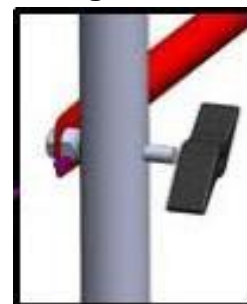


- Place the trapdoor platform on the 16<sup>th</sup> rung and hook and secure J bolts to all 4 corners (Figure 12). Fasten all remaining hanging red braces horizontally using the wing nuts and bolts provided to make knee rails and hand rails (Figure 13). **WARNING! Remember to sit inside the trapdoor whilst installing all the red braces for safety.**

**Figure 12.**



**Figure 13.**



### **Dismantle Procedure**

To take down the tower reverse the erection sequence. When removing red guardrail braces at the top of the tower remember to sit inside the trapdoor platform. You can refit the platform further down the tower to aid in dismantling it.